

MODEL 160X/XT

Single - Channel Compressor / Limiter

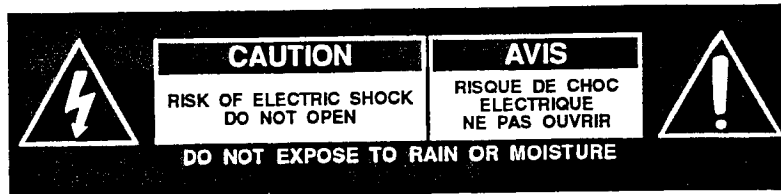

SERVICE MANUAL
(Preliminary)



CAUTION: TO REDUCE THE RISK OF ELECTRICAL SHOCK, DO NOT REMOVE COVER (OR BACK). NO USER SERVICEABLE PARTS INSIDE. REFER SERVICING TO QUALIFIED SERVICE PERSONNEL.

WARNING: TO REDUCE THE RISK OF FIRE OR ELECTRICAL SHOCK, DO NOT EXPOSE THIS APPLIANCE TO RAIN OR MOISTURE.



This symbol, wherever it appears, alerts you to the presence of uninsulated dangerous voltage inside the enclosure — voltage that may be sufficient to constitute a risk of shock.



This symbol, wherever it appears, alerts you to important operating and maintenance instructions in the accompanying literature. Read the manual.

Manufactured under one or more of the following U.S. patents: 3,377,792; 3,681,618; 3,714,462; 3,789,143; 4,097,767; 4,329,598; 4,403,199; 4,409,500; 4,425,551; 4,473,795. Other patents pending.

This dbx-branded product has been manufactured by AKG Acoustics, Inc.

AKG is a registered trademark of Akustische u. Kino-Geräte Ges m.b.H., Austria. All trademarks are property of their respective companies.

This manual is part number 96010-000-02

© Copyright 1993 by AKG Acoustics, Inc.

150 - FB - 1/93

dbx

dbx Professional Products

a division of AKG Acoustics, Inc.

1525 Alvarado Street, San Leandro, CA 94577 USA

Telephone (1) 510/351-3500 Fax: (1) 510/351-0500

QUICK SETUP

To get your unit up and running as quickly as possible, do the following steps. For more detailed information, refer to the specified pages.

- Unpack and Inspect the 160XT Package. Page 2
- Complete the Registration Card. Page 2
- Mount Unit in a Rack (OPTIONAL). Page 18
- Connect Audio Inputs and Outputs. Page 19
- Connect Power. Page 22
- Set Levels and Controls as Needed. Page 4

INSPECTION

1. Unpack and Inspect the 160XT package.

Your 160XT was carefully packed at the factory in a protective carton. Nonetheless, be sure to examine the unit and the carton for any signs of damage that may have occurred during shipping. If obvious physical damage is noticed contact the carrier immediately to make a damage claim. We suggest saving the shipping carton and packing materials for safely transporting the unit in the future.

Verify that the 160XT package contains the following:

- 160XT Unit
- 160XT Accessory Kit
- Operation Manual
- Warranty Certificate/Registration Card

2. Please complete the Registration Card and return it.

Please fill in the Registration Card, detach it from the Warranty Certificate, and send the card to us today.

The Registration Card enables us to inform you of new applications and performance improvements that are developed, and it helps us respond promptly to claims under warranty without having to request a copy of your bill of sale or other proof of purchase.

INTRODUCTION

Congratulations on purchasing the dbx Model 160XT Compressor/Limiter. We recommend you take a moment and read through the manual as it provides information that will assist you from system installation to operation to special applications.

We have added a few new features to the dbx Model 160XT while maintaining the performance and ease of operation of its predecessor, the dbx 160X. We have added:

- XLR-type Input and Output Connectors – because the 3-pin XL connector has been recognized as the most durable and widely used connector for professional applications.
- Balanced Output – can drive a 600 Ω load to +24dBu and provides common-mode rejection of unwanted noise in the audio path such as RF and 60Hz components.
- True Power Summing – When two 160XT units are slaved together, the RMS energy of the signal presented to the slave unit is summed with the RMS energy of the signal presented to the master unit to prevent phase cancellation of the two signals from causing unmusical compressor action. Note: a 160X unit can also be used with the same results as long as the 160XT is used as the master unit.
- Input Ground-Lift Switch – for isolation between shield ground and signal ground. Useful when troubleshooting hum (AC line interference).

Other features include:

- OverEasy[®]/Hard Knee Selection – allows selection between our famous OverEasy compression curve and the classic “Hard Knee” curve popularized by the original dbx 160, 161 and 162.
- True RMS Level Detection – senses the power in the program in a musical manner, much as the ear does, giving results superior to peak or average detection.
- Hardwire System Bypass Switch – allows the audio to pass even if the unit is unplugged, and is also useful for comparing the processed and unprocessed signal.
- Front Panel Stereo Coupling Switch – couples two 160XTs or a 160XT and a 160X together for stereo operation at the push of a button.
- 19 Segment Display – for high resolution monitoring of True RMS input and output levels.

- 12 Segment Display – indicating GAIN REDUCTION.
- Meter Calibration – input/output meter calibration, so the 160XT can be used in a variety of situations where the “0” reference is not consistent.
- ¼” Input and Output Connectors – we kept the ¼” phone jacks from the 160X, with the output capable of driving its own additional 600Ω load (single-ended) in addition to any load at the XL output.
- Detector Input – useful for special applications including frequency conscious compression in which an external equalizer is used.
- DC-controlled Parameters – the signal does not pass thru any of the parameter controls. Instead a DC voltage controls all functions which eliminates any possibility of potentiometer noise as the controls age.

Applications

The dbx 160XT is capable of handling a wide range of applications. In the studio, the 160XT can be used on everything from vocals to percussion. In live sound reinforcement, the 160XT can allow the engineer to get that “fat studio sound” out of the drum kit or provide protection limiting for the speakers. In radio or television broadcast, the 160XT will produce stable voice levels, even with non-professional subjects.

OPERATING CONTROLS

Front Panel

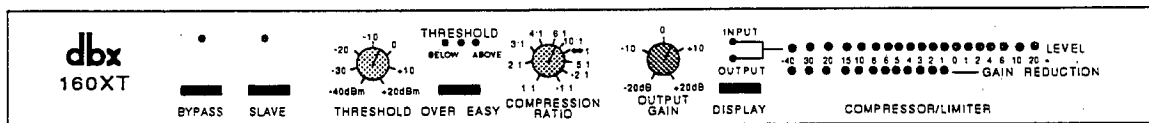

Figure 1: Front Panel

BYPASS Switch and Indicator Depressing the BYPASS button creates a “hard-wire bypass” of the 160XT’s circuitry by connecting the input directly to the output; If the 160XT is being provided with AC power, an LED above the switch turns ON in Bypass mode.

SLAVE Switch and Indicator Depressing the SLAVE button on one 160XT of a stereo pair determines that the *other* 160XT will be the Master (the controlling unit). The LED above the SLAVE button turns ON when the 160XT is in Slave mode, indicating that the front panel functions (with the exception of BYPASS and DISPLAY select switches) are deactivated and under control of the Master 160XT. When neither 160XT is in Slave mode, each will operate normally as a single channel compressor/limiter.

THRESHOLD Control Adjusting this knob sets the threshold of compression from -40dBu (7.8mVrms) to $+20\text{dBu}$ (7.8Vrms).

OverEasy Switch Depressing this button selects the OverEasy[®] compression characteristic. The amber THRESHOLD LED turns ON when the signal is in the OverEasy region. When this button is out, the 160XT operates as a hard-knee compressor/limiter.

In hard-knee compression mode, the threshold is defined as that point above which the output level no longer changes on a 1:1 basis with changes in the input level. In OverEasy mode, the threshold of compression is defined as the middle of the OverEasy threshold region, that is, "half-way" into compression, as shown in Figure (See Figure 3).

THRESHOLD Indicators These three LEDs indicate the relationship of the input signal level to the threshold of compression. The green "BELOW" LED is ON when the signal is below threshold and the red "ABOVE" LED is ON when the signal is above threshold. When the 160XT is switched to OverEasy mode, the amber LED is ON when the signal is in the OverEasy region (See Figure 3).

COMPRESSION RATIO Control Rotating this control clockwise increases the amount of compression from 1:1 (no compression) up to infinity:1 (no increase in output level, regardless of input level increases above threshold); further clockwise rotation increases compression into the INFINITY+ region, up to a maximum of $-1:1$ (i.e., a 1dB *increase* in input level above threshold causes a 1dB *decrease* in output level). In the INFINITY+ region, the 160XT inverts the program dynamics for special effects.

OUTPUT GAIN Control Adjusting this control varies the amount of fixed gain (up to $\pm 20\text{dB}$) in the 160XT's output amplifier stage. The OUTPUT GAIN control does not interact with the threshold of compression.

DISPLAY Switch and Indicator Depressing this button causes the upper LED array to display the INPUT level to the 160XT. With the button out, the OUTPUT level is displayed. A pair of LEDs immediately above the DISPLAY switch indicates the selected display status.

LEVEL and GAIN REDUCTION Displays The upper row of 19 LEDs displays either the INPUT or OUTPUT level, as selected with the DISPLAY switch. This display is factory set so that 0dB is equivalent to +4dBu input or output level (1.23Vrms), but may be reset with the rear panel METER CALIBRATION trimmer. (See following pages.) The lower row of 12 LEDs displays up to 40dB of GAIN REDUCTION caused by the 160XT. (Fixed gain changes due to the OUTPUT GAIN control are not displayed by the GAIN REDUCTION LEDs but are reflected in the OUTPUT level display.)

Rear Panel

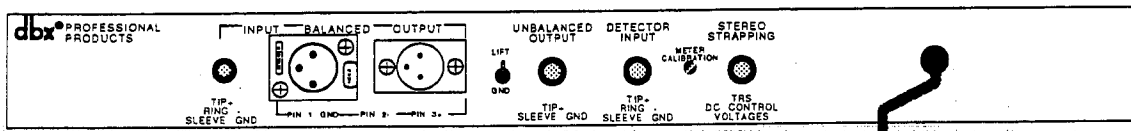

Figure 2: Rear Panel

SIGNAL INPUT Jacks The Tip/Ring/Sleeve phone jack and XLR-type connector are wired in parallel; either Signal Input will accept an audio signal for processing by the 160XT. The phone jack accepts a standard TRS 1/4" phone plug for a balanced input source, or a 2-circuit (Tip/Sleeve) 1/4" phone plug for an unbalanced source. The XLR-type plug connector is wired pin 3 HOT (+), pin 2 COLD (-) and pin 1 GROUND.

DETECTOR INPUT This Tip/Ring/Sleeve phone jack accepts a standard TRS 1/4" phone plug, and is of the "normalling" type. That is, when a phone plug is inserted, the detector input is no longer connected in parallel with the audio input.

SIGNAL OUTPUT – XLR-type connector The 160XT has an active-balanced amplifier capable of driving a 600 ohm (or greater) load to +24dBu. Pin 3 is the HOT (+) lead, pin 2 is the COLD (–) lead and pin 1 is circuit ground. Do not short either pin 2 or pin 3 to ground. This will not damage the unit, but may increase distortion.

SIGNAL OUTPUT – Phone Jack The 160XT has a separate single-ended (unbalanced) output amplifier also capable of driving a 600 ohm (or greater) load to +24dBu. In normal operation the Tip/Ring/Sleeve phone jack is internally wired with the TIP HOT (+), and the RING and SLEEVE connected to circuit ground. In BYPASS mode, however, the RING is connected to the COLD (–) leads of the input jacks, to allow for 1:1 connections.

GROUND (GND) Lift Switch This switch allows for troubleshooting hum (line interference) caused by ground loops. In the “GND” position, pin 1 of the input XLR-type connector is connected to the 160XT’s circuit ground. In the “LIFT” position it is disconnected. This is not a chassis-isolate switch. The circuit ground is floating with the respect to the chassis.

METER CALIBRATION Control This screw-driver-adjustable trimmer may be used to precisely calibrate the front panel’s upper LED display so a 0dB INPUT or OUTPUT indication is equivalent to any signal from –15dBu (138mVrms) to +10dBu (2.45Vrms).

STEREO STRAPPING Jack When a TRS (Tip/Ring/Sleeve) ¼” phone plug patch cable is inserted between two 160XTs, stereo strapping can be achieved by depressing the SLAVE switch on one unit only. This will provide accurate processing for a stereo programming.

AC Cord: Plug into mains power. Note that the 160XT does not have a power switch. It is recommended that the 160XT be “On” at all times. Power consumption is low. If you do not plan to use the 160XT for an extended period of time, unplug it.

WARNING: Be sure to verify both your actual line voltage and the voltage for which your Model 160XT was wired, as indicated on the rear panel of your unit. Connection to an inappropriate power source may result in extensive damage which is not covered by the warranty.



OPERATING NOTES

Basic Operation

Using the THRESHOLD control

In hard-knee mode this control sets a reference level above which input signals will be processed by the 160XT's gain change circuitry in the manner defined by the setting of the RATIO control. Input signals which fall below this level will pass through the 160XT unprocessed (except for fixed gain changes directed by the output control). See Figure 4.

In OverEasy Mode, signals begin to gradually activate the 160XT's gain change circuitry as they approach the THRESHOLD reference level and they do not get fully processed in the manner defined by the RATIO control until they have passed somewhat above the THRESHOLD reference level. In OverEasy mode there is no distinct point at which processing begins, and the THRESHOLD setting corresponds to a point on the input/output transfer curve midway between the onset of processing and that point at which the transfer curve corresponds to the setting of the RATIO control (Figure 3). Figure 3 also shows how the 160XT's THRESHOLD indicator LEDs correlate with the compression curves.

NOTE: The THRESHOLD setting relates to the signal level seen by the DETECTOR INPUT. In normal operation, the program input SIGNAL INPUT is connected directly to the DETECTOR INPUT. If this is not the case, the signal actually present at the DETECTOR INPUT will determine how the 160XT processes the signal coming into its SIGNAL INPUT.

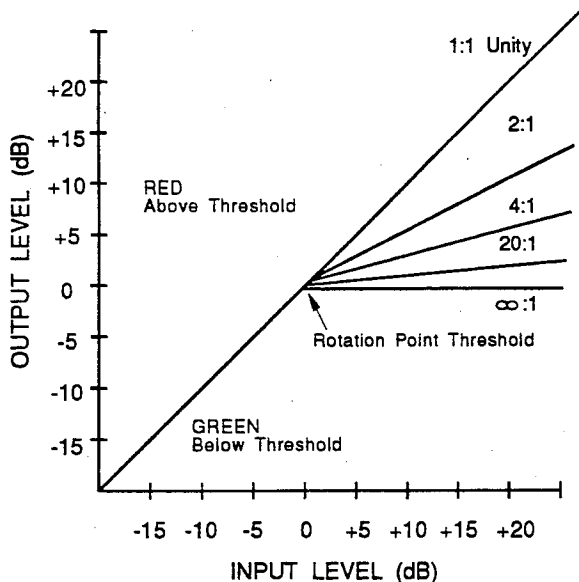

Figure 4: Hard-Knee Compression Curve

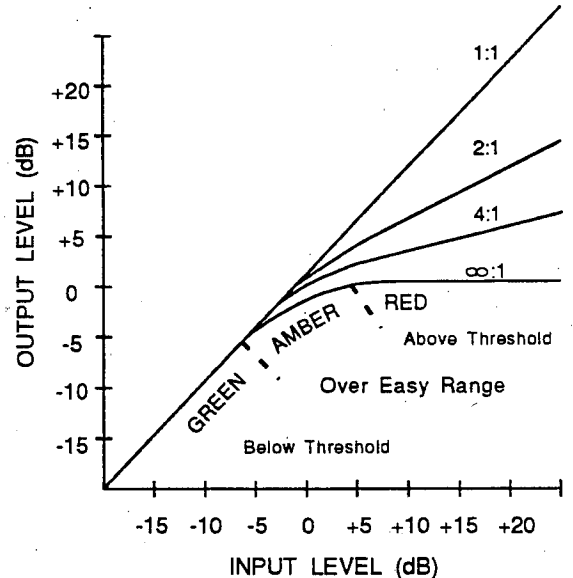

Figure 3: Over Easy Compression Curve

Using the COMPRESSION RATIO control

When an input signal is above the THRESHOLD reference level, the setting of this control determines the number of decibels by which the input signal must change in level to produce a 1dB increase in the signal level at the output of the 160XT. A setting of 2:1 indicates an input:output ratio wherein a 2dB increase in signal (above threshold) will produce a 1dB increase in output signal. A setting of ∞ :1 indicates that an infinite increase in input level would be required to raise the output level by 1dB. In other words, the output level is constant when the input signal is above threshold.

The 160XT's RATIO control covers the entire range from 1:1 to ∞ :1 and, in addition, goes to Infinity+ (negative) ratios. At a setting of -1:1, the above threshold input signal must increase by 1dB in level to decrease the signal at the output of the 160XT by 1dB. See Figure 5.

The control curve of the RATIO potentiometer has been designed to provide total operator control, with scale expansion at the subtle lower ratios for easy, repeatable settings.

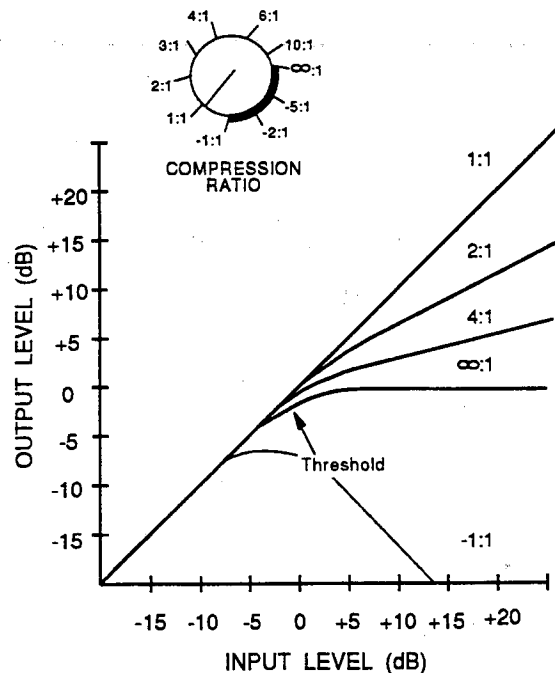

Figure 5: Ratio control and Infinity+ (Negative) Ratios

Using the SLAVE button (Stereo Operation)

Two channels of program material do not necessarily constitute a stereo program. A stereo program is one where the two channels are recorded and/or mixed to create the illusion of a single unified "panorama" of sound. The stability of the psychoacoustic "image" of each sound source within the stereo program depends upon its ability to maintain a specific phase and amplitude relationship from left to right channel.

If two independent compressors are used to process the stereo program, a loud sound occurring in one channel will cause a gain reduction only in that channel. This gain reduction would cause the perceived image of any sound spread between the two channels to move toward the side which had not been compressed, because the spread signal would be momentarily softer in the compressed channel. This can be avoided by linking the two compressors in such a way that both channels receive the same amount of compression. On the 160XT, this is accomplished by means of the STRAPPING jacks; a cable between these jacks permits the RMS detectors of both units to "talk" to one another — but only when one of the units' SLAVE buttons is depressed. The SLAVE unit then sends its signal to the MASTER, where the RMS power of the MASTER and SLAVE signals are combined to generate a control voltage. This control voltage is then used to compress both the MASTER and SLAVE units equally.

When compressing a stereo program with a pair of 160XTs, only the MASTER unit controls need to be adjusted.

METER CALIBRATION control

The INPUT/OUTPUT LEVEL DISPLAY in the 160XT is factory-calibrated to indicate "0" when the signal is +4dBu (1.23Vrms) at either the input or output of the 160XT, depending on the DISPLAY function switch position. (The METER CALIBRATION control does not affect the GAIN CHANGE LEDs.)

To recalibrate the LEVEL DISPLAY, depress the DISPLAY button to meter the INPUT LEVEL, and feed a 1kHz signal at the selected nominal operating level (the level desired for a "0dB" meter indication) to the 160XT's SIGNAL INPUT. Then adjust the rear panel METER CALIBRATION control until the meter indicates "0dB."

Specific Applications

Smoothing out variations in microphone levels

When the distance between a vocalist and a mic changes, variations in signal level occur. To smooth out these variations, start with the 160XT adjusted for a low COMPRESSION RATIO (e.g., 4:1) and adjust the THRESHOLD control for optimum results, then increase COMPRESSION RATIO if necessary. Due to the gentle OverEasy characteristic of your 160XT you will find that even fairly high ratios are handled transparently.

Smoothing out variations in musical instrument levels

To achieve a smoother electric bass sound, compress the instrument's output with a ratio of about 4:1 (the COMPRESSION RATIO control set at approximately 12:00). Compression lessens the loudness variations among the strings and increases the sustain. Other instruments, such as horns, vary in loudness depending on the note being played, and benefit similarly.

NOTE: When compressing a stereo program with a pair of 160XTs, the factors affecting a compression curve and the actual compression ratio and threshold settings, are like those previously covered with reference to single channels of program material. However, it will generally be found that large amounts of compression are more audible in a mixed stereo program than they might be on the separate tracks that were mixed to create the program.

Raising a signal out of a mix

Since reducing dynamic range increases the *average* signal level by a small amount, a single track can be raised out of a mix by boosting its level slightly and applying compression. It is also possible to separate certain vocals or instruments from a mono program already mixed by frequency-weighted compression (see page 12).

Using your EQ to reduce feedback in live settings.

You can use your 160XT and EQ to reduce feedback in clubs or halls by placing the 160XT at ∞ :1, Hard Knee, and a low threshold. Increase control gain until the first feedback "ring" occurs. The 160XT will catch it, and hold it as a constant tone so you can adjust your EQ to minimize it. Continue to increase your console gain and set your EQ until the 3 or 4 "ring" frequencies have been compensated for.

Preventing tape saturation

With programs of widely varying levels, compression can prevent recording levels from saturating tape tracks (see Frequency-weighted compression, page 12).

Speaker protection

Compressors are frequently used to prevent excessive program levels from damaging drivers in a sound-reinforcement system. Limiting also benefits intelligibility by allowing low-level input signals to be reproduced through the system at higher volume. In a musical performance, this provides additional intimacy as the vocalist's whispers are heard clearly at every seat in the house. The OverEasy curve available with the 160XT permits a very high amount of COMPRESSION (10:1 or greater) to be used in many situations. Vocalists and musicians don't get the sense of being held back, but high average levels can be maintained without speaker damage due to excessive heat buildup.

In circumstances where the 160XT is expected to cause no change in gain unless an emergency arises (wildly excessive levels) some operators set the COMPRESSION RATIO to $\infty:1$, the THRESHOLD to the highest permissible level, and operate the unit in hard-knee mode. As a general rule, the compressors should be as close to the amplifiers as possible in the signal chain. If the 160XT is placed before the EQ, for example, a potentially damaging boost in EQ won't be seen by the 160XT and the speakers may be damaged. (see Multi-way speaker systems, page 14).

For maximum sound pressure levels, large sound reinforcement systems frequently use a separate compressor on each output of the electronic crossover(s). For a stereo sound-reinforcement system, stereo strapping cables should be run between the 160XTs in each band (low-low, mid-mid, etc.).

The 160XT as a line amplifier

To use the 160XT as a line amplifier, adjust the COMPRESSION ratio control to fully counterclockwise (1:1 position), THRESHOLD to full clockwise position (+10) and OUTPUT GAIN to whatever setting is required for the application. Remember that, as with any amplifier, excessive gain may lead to output clipping of high level signals. To add compression, adjust the COMPRESSION ratio and the THRESHOLD controls to the desired settings.

Side-chain applications

Frequency-weighted compression

It is possible to separate certain vocals and instruments from a mix by frequency-weighted compression. With an equalizer inserted ahead of the detector input (but not in the audio path), the equalization settings do not shift the timbre or frequency response of the audio signal. They merely alter the threshold response of the compressor on a "frequency-weighted" basis (see Figure 6).

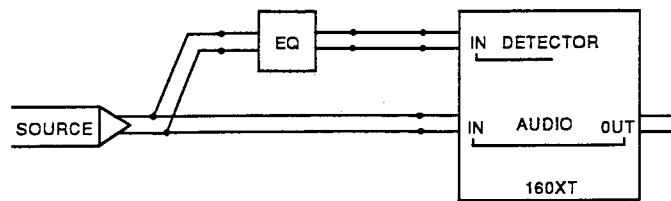

Figure 6: Frequency-Weighted Compression

With this arrangement, raising certain frequencies on the equalizer causes them to be suppressed in the audio signal. A relatively high THRESHOLD setting can allow normal sounds to be unaffected while solo and very loud sounds are held back. (Of course, when compression does occur, the level of the entire program is affected.) Depending on the THRESHOLD setting, lower level fundamentals or harmonics will not cause compression, and the program is not subject to the phase shift normally caused by program equalization.

During the recording of cymbals and tom-toms, a compressor with an equalizer in the detector path can help prevent tape saturation. The equalizer can be adjusted for boost with a peak of about 5kHz, causing the cymbal to be compressed on a very loud crash, stopping tape saturation at high frequencies, where there is less headroom. However, gentle tapping of a drumstick or brushing of the cymbal will not be held back. Assuming the tom-tom is a lower frequency instrument and can be better tolerated by the tape, it has less need for compression. The equalization in the detector circuit means that the compressor is not triggered as readily by a loud tom-tom beat as by an equally loud cymbal crash.

The converse of the above EQ technique may be used: dipping the equalizer bands causes any sound with dominant energy in the affected register to pull the level up because the 160XT will detect a need for less compression.

De-Essing

To apply de-essing to vocals (i.e., a reduction of sibilance), use a parametric equalizer in the level detector circuit and set it for high frequency boost in the specific frequency range where the vocal "hiss" or lisp occurs (generally in the 4-6kHz region). This pre-emphasizes the already "hissy" vocal input to the detector. Used in conjunction with a moderate to high threshold and compression ratio, this arrangement greatly attenuates the "essing" without affecting the basic sound quality or balance of the voice.

While it is true that all frequencies are lowered in level when the compressor is triggered, generally the "sss" sound occurs alone, before or after the dominant tone in the voice.

Increasing sustain

To increase the sustain of a musical instrument (e.g., a guitar or bass), use an equalizer in the level detector circuit and boost the EQ in the dominant frequency range of the instrument, along with a fairly low threshold and a moderate compression ratio.

Using a Filter in the Level Detector Circuit

The results of inserting a filter in the level detector circuit are basically the same as obtained with an equalizer, as previously described. Those frequencies passed by the filter are subject to compression (or at least they are subject to considerably more compression than those frequencies outside the passband). Because a passive filter can have insertion loss, it may be necessary to lower the 160XT's THRESHOLD setting to maintain a given amount of gain reduction within the filter passband; this can be determined by monitoring the 160XT's threshold indicator LEDs.

Multi-way speaker systems

If a single compressor is to be used with a multi-way speaker system (i.e., before the crossover, after EQ), the system operator is faced with the problem of keeping levels below the point of destruction of the most sensitive part of the system. If, for example, mid-range drivers are frequently damaged, the whole system must be operated at a lower sound-pressure level, or additional mid-range drivers must be added. By inserting an equalizer in the detector path to the 160XT, it can be made more sensitive to frequencies in the range handled by the sensitive drivers. The system can then be run at higher levels and will only be dropped back when damaging signals are present.

Pre-emphasis for broadcast applications

By inserting a pre-emphasis filter network in the detector path of a 160XT processing pre-emphasized audio, higher levels can be run within the headroom limitations of the broadcast chain.

Anticipated Compression

By feeding the program directly to the 160XT's detector input and sending the audio signal through a delay line before the audio input, the unit can anticipate the need for a gain change. See figure 7. With some experimentation, the effect can be that of zero attack time at a given frequency. Additional signal delays beyond this zero time will then cause the compressor to finish reducing the gain before the leading edge of the loud passage

even enters the signal input. This will suppress the program material preceding this loud passage. The 160XT will then begin to release (recover from compression) before the loud passage has ended.

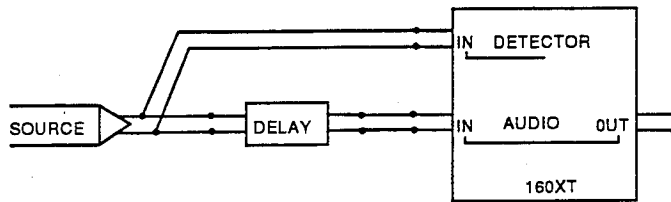

Figure 7: Anticipated Compression

CONNECTING THE 160XT TO YOUR SYSTEM

Basic Connection

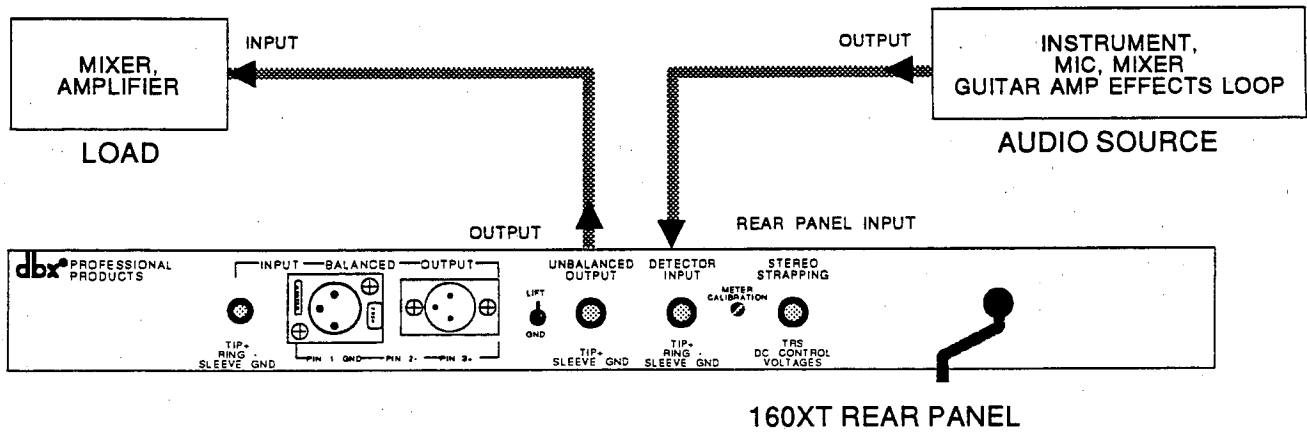

Figure 8: Basic Connection

The 160XT can be connected for basic operation as shown in Figure 8.

For more specific installation information, refer to Installation Considerations, page 18.



For all connections, refer to the following steps:

- A. Turn Off all equipment before making any connections.
- B. Make connections via XLR or 1/4" TRS jacks according to your requirements.
- C. Plug in the AC power cable to power On the unit.

Multi-Channel Connections

The 160XT can be "strapped" to another 160XT for 2-channel stereo operation. This will force one of the units (SLAVE) to track the other (MASTER) to preserve proper stereo imaging. A 1/4" stereo phone cable is required to connect the two 160XTs together.

To operate in stereo, designate one of the two units to be a "MASTER" (SLAVE button OUT) and switch the other unit to "SLAVE" mode (SLAVE button IN, SLAVE LED ON).

The master 160XT will now respond to the combined inputs of the 160XTs. The master's controls will adjust the amount and nature of the compression and the slave will track accurately.

When the SLAVE switches on both units are not depressed, the 160XTs operate completely independently. If both SLAVE buttons are depressed, both units will be bypassed (i.e., fixed at unity gain).

The strapping cable with 1/4" TRS plugs on both ends may be left in place when both 160XTs are to be used independently (i.e., both as MASTER).

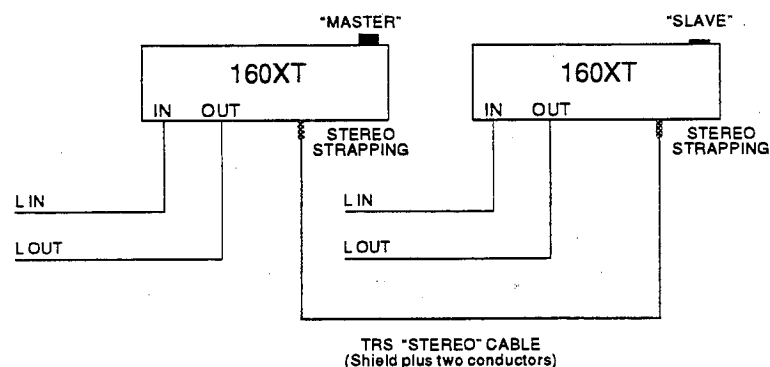

Figure 9: Multi-Channel Connections

Using External Level Detector Inputs

To control the compressor by signals other than the audio input (via an auxiliary device), connect the auxiliary device's output to the 160XT's Detector Input jack, and feed the auxiliary device's input with the same signal fed to the 160XT's Signal Input (Figure 10). This will require a Y-adaptor, or you can take advantage of the 160XT's parallel input jacks.

In certain situations, the auxiliary device may need to be inserted in the signal path, not in the detector path. In such cases, signal is fed to the input of that device, and also to the detector input, and the auxiliary device's output is fed to the 160XT signal input (for example, using a delay to create "negative" attack times) (Figure 10).

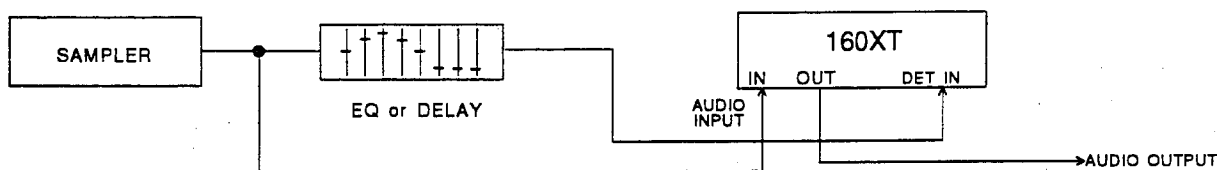

Figure 10: Using the 160XT with a Sampler

Specific System Connections

The 160XT has balanced inputs and outputs, and can be used with any line-level device. Some common examples include: mixing consoles, musical instruments, patch bays, and other signal processors.

Mixing Board

If you wish to compress a particular track of a multi-track recording or one channel of a live performance mix, the 160XT output can be directly connected to a line input jack (balanced or not), or wired to an Insert point. In the latter case, the signals will most likely be unbalanced.

Musical Instruments (i.e., Electric Guitar, Bass, Keyboards)

The output of an electric guitar is sometimes not "hot" enough to drive the 160XT's input. When this is the case, you should use the "PREAMP OUT" of your guitar amp (if so equipped), or the output of some other device that is designed to accept low-level instrument inputs (including various stomp boxes and rack mount audio products, like the dbx Performer Se-

ries processing units). Such sources can be balanced or unbalanced — this is no problem for the 160XT.

Microphones and bass guitars, like guitars, typically have low-level outputs.

Instruments like keyboards typically produce a line-level signal and can be connected directly from the instrument's output to the 160XT's input.

Patch bay

In the studio, the 160XT may be connected to a patch bay to allow it to be used anywhere in the studio system. Do not ground Pin 2 (or 3) of the XLR-type output connector (distortion can result). If your studio is not fully balanced, you should leave pin 2 disconnected or use the 1/4" phone jack output, which is single-ended. Another option is to install an output transformer, which will allow grounding of either pin 2 or 3 of the XLR-type output (see page 24).

Sound reinforcement:

To compress a live mix or to protect loudspeakers, connect the 160XT between the source (mixing board or distribution amp) and the power amp(s). If multi-way loudspeakers with low-level electronic crossovers are used, the 160XT(s) should go after the crossover(s). For a stereo system, you can separately stereo couple the two high band crossovers, low band crossovers, etc. (see page 16). If limitations require that you use a single 160XT before a crossover, adding an equalizer to the side chain may provide some additional protection to your high frequency component (see "Speaker Protection," page 12).

INSTALLATION CONSIDERATIONS

Mounting the 160XT in a Rack (OPTIONAL)

Mount the 160XT in a 1U rack space (1.75 inches, 4.45 cm).

Mounting the unit directly over large heat-producing devices (such as a vacuum-tube power amplifier) may shorten component life and is not recommended. Ambient temperatures should not exceed 113°F (45°C) when equipment is powered.



Caution: Never remove the cover. There are no user-serviceable parts inside, and you run the risk of an electric shock.

Input/Output Cable Configurations

Hookups and Cabling

The 160XT is a 600 Ω , balanced (differential) unit designed for nominal +4dBm levels; inputs and outputs are tip/ring/sleeve phone jacks and XLR connectors. The 160XT can be used with either balanced or unbalanced sources and outputs can be used with either balanced or unbalanced loads, provided you use proper cabling.

A balanced line is defined as two-conductor shielded cable with the two center conductors carrying the same signal but of opposite polarity with respect to ground. An unbalanced line is generally a single-conductor shielded cable with the center conductor carrying the signal and the shield at ground potential.

Connect Audio Inputs

The 160XT has an actual input impedance of 100k Ω in balanced configuration or 50k Ω if unbalanced. This makes the 160XT audio input suitable for use with virtually any source impedance, low or high. The 160XT's input connectors are wired in parallel. That is, the phone jack TIP (+) connection is internally wired to the XLR-type pin 3, the RING (-) is wired to pin 2, and the SLEEVE (shield) is wired to pin 1. Note that pins 2 and 3 are the reverse of certain other manufacturer's equipment, but if the same connection is used at the output, the signal will be correctly polarized ("in phase").

Reversing the input wires to the input terminals will result in the output signal polarity being the opposite of the input signal ("180° out of phase").

The 160XT has a rear-panel GROUND LIFT switch. This switch disconnects the input XLR-type pin 1 from the 160XT's circuit ground. This is to allow troubleshooting of hum and other grounding problems without having to change the cabling. We advise starting with the switch in the LIFT position (shield disconnected at the 160XT input).

Output Cable Considerations

Connect Audio Outputs

The model 160XT has two separate outputs: one single-ended amplifier driving the 1/4" stereo phone jack, and a separate active-balanced amplifier driving the XLR-type output connector. Each is capable of driving a 600 ohm load to +24dBu.

NOTE: Contact our Customer Service Department for information regarding factory installation of the optional balanced transformer. Our phone number is listed on the inside of the front cover.

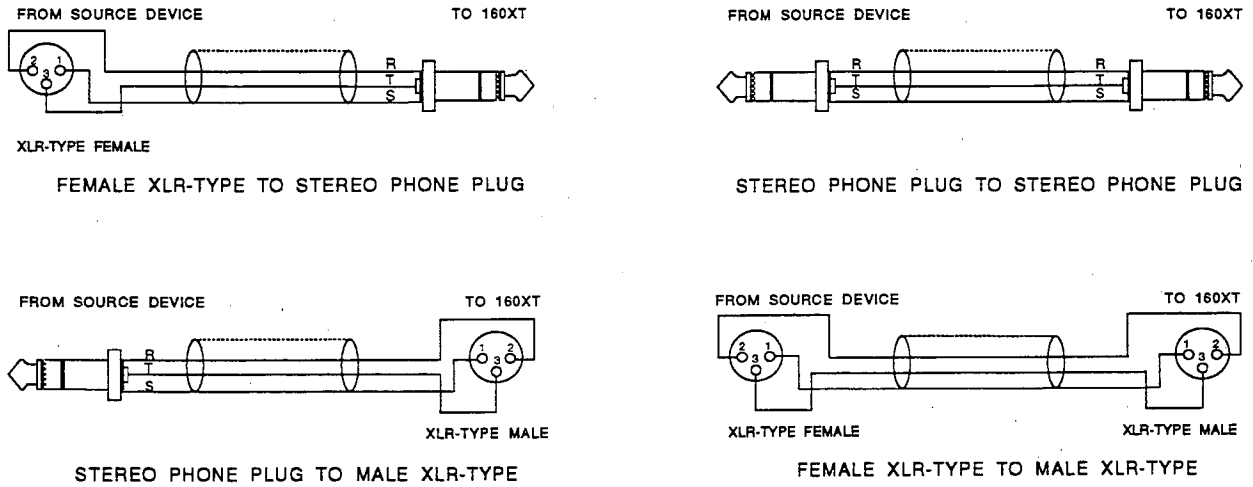

Figure 11: Input Connections (Fully-Balanced Operation)

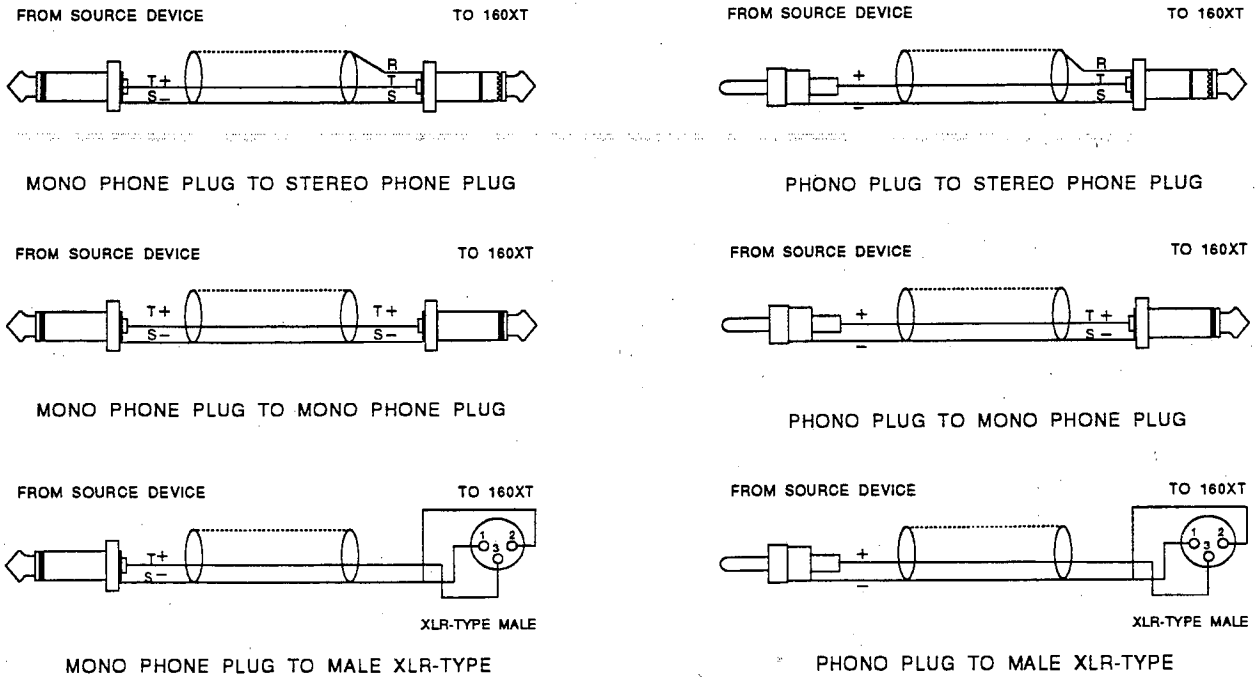

Figure 12: Input Connections (Unbalanced Operation)

NOTE for using 1/4" Mono Phone Connectors:

Connect the Sleeve to the cable's shield.

In an emergency, 1/4" Mono Phone cables will work (for inputs only)

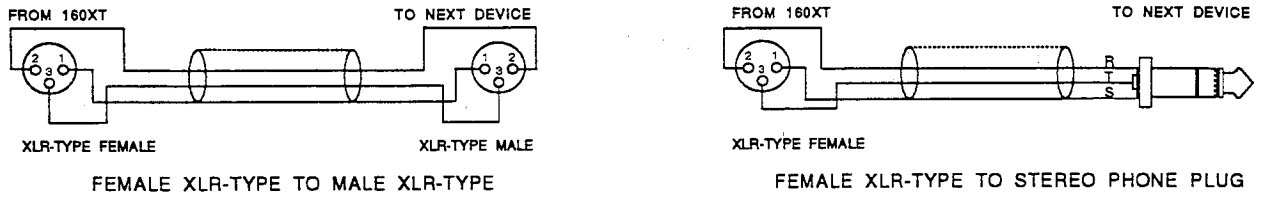

Figure 13: Output Connections (Fully Balanced Operation)

NOTE for using 1/4" Stereo Phone Connectors:

If the 160XT is wired into a patchbay, never insert a mono phone plug into the patchbay.

The Ring conductor is never connected to anything when the 160XT is driving single-ended inputs. Leave it floating.

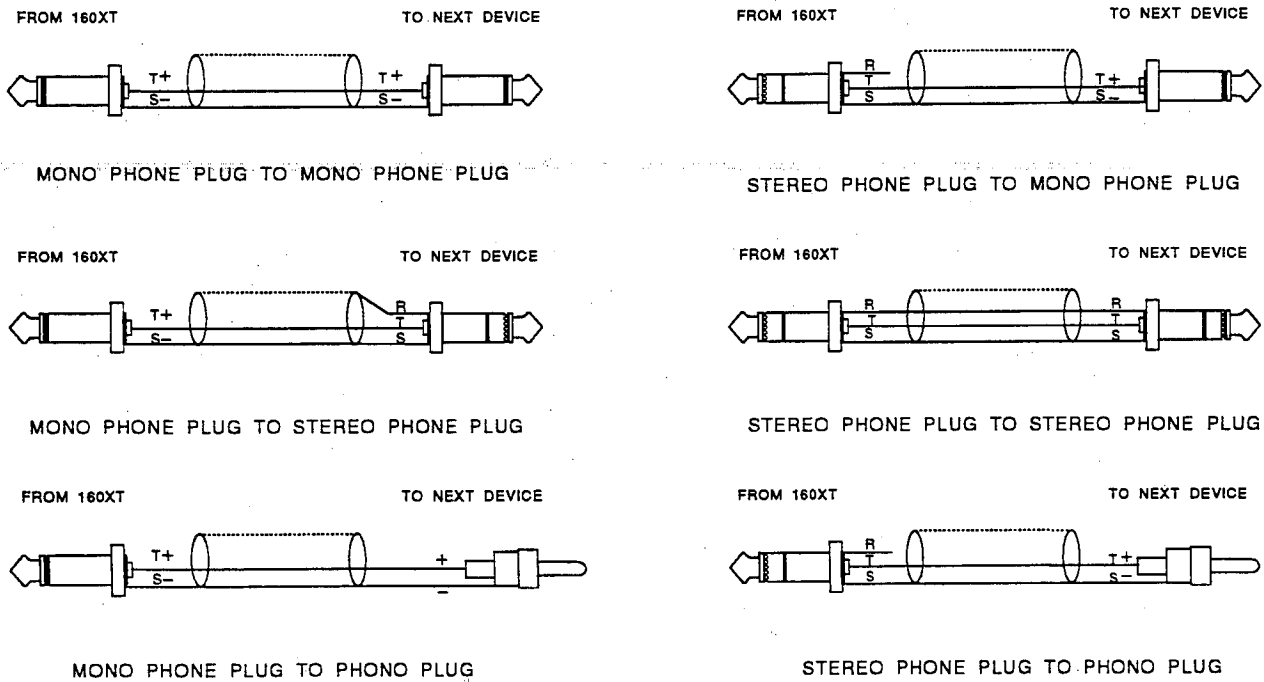

Figure 14: Output Connections (Unbalanced Operation)

NOTE for using 1/4" Stereo Phone Connectors:

If you are using a Stereo phone plug at the next device, tie the Ring and Sleeve together, and connect the sleeve to the wire's Shield. This is equivalent to a cable with 1/4" Mono Phone plugs on both ends.

NOTE for using RCA Phono Connectors:

The Ring conductor is never connected to anything when the 160XT is driving single-ended inputs. Leave it floating.

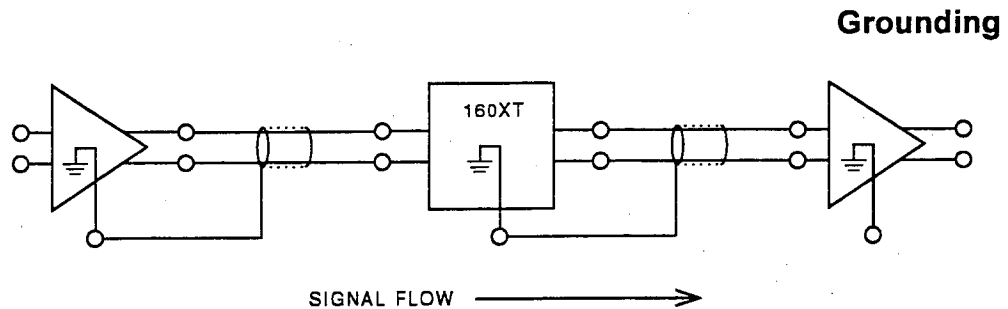

Figure 15: Signal Flow (Balanced Connection)

NOTE: For maximum hum rejection, avoid common grounding at the 160XT's input and output. The best starting point is to ground the shield of the input cable at the source device (leaving it unconnected at the 160XT) and to ground the shield of the output cable to the ground terminal of the 160XT (leaving it unconnected at the receiving device). The Ground Lift switch can be used to lift the shield at the 160XT's input.

Connecting Power



- A. Check the line voltage.

The 160XT is shipped for 115V or 230V, 50 or 60Hz operation. Refer to the unit's rear panel to verify your unit's precise line voltage.

- B. Connect the 160XT's power cord to an appropriate AC power source.

TECHNICAL SUPPORT, FACTORY SERVICE

The 160XT is an all-solid-state product with components chosen for high performance and excellent reliability. Each 160XT is tested, burned in and calibrated at the factory and should require no internal adjustment of any type throughout the life of the unit.

Technical Support

If you require technical support, contact dbx Customer Service. Be prepared to accurately describe the problem. Know the serial number of your unit — this is printed on a sticker attached to the rear panel.

Telephone: (1) 510/351-3500

or Write: dbx Professional Products
a division of AKG Acoustics, Inc.
1525 Alvarado Street
San Leandro, CA 94577 USA
ATTN: Customer Service

or Fax: (1) 510/351-1001

Factory Service

Before you return a product to the factory for service, we recommend you refer to the manual. Make sure you have correctly followed installation steps and operation procedures. If you are still unable to solve a problem, contact our Customer Service Department for consultation. Often, a problem is relatively simple and can be quickly fixed after telephone consultation. If you need to return a product to the factory for service, include a letter describing the problem.

Please refer to the terms of your Limited Two-Year Standard Warranty, which extends to the first end-user. After expiration of the warranty, a reasonable charge will be made for parts, labor, and packing if you choose to use the factory service facility. In all cases, you are responsible for transportation charges to the factory. dbx will pay return shipping if the unit is still under warranty.

Use the original packing material if it is available. Mark the package with the name of the shipper, and with these words in red:

DELICATE INSTRUMENT, FRAGILE!

Insure the package properly. Ship prepaid, not collect. Do not ship parcel post.

SCHEMATICS

The Schematic for the 160XT boards and power supply are provided on the inside back cover.

SPECIFICATIONS

(NOTE: 0dBV = 1.0VRMS; 0dBu = 0.775VRMS)

Specifications are subject to change.

Frequency Response	20Hz-20kHz (± 0.5 dB)
Input Rear Panel Maximum Input Level Connector Type Detector Input Impedance Maximum Detector Input Level Detector Connector Type	Balanced: 100k Ω / Unbalanced: 50k Ω +24dBu (12.3Vrms) 1/4" TRS Phone Jack and XLR-type Connector Balanced = 460k Ω / Unbalanced = 230k Ω +28dBu (19.5Vrms) 1/4" TRS Phone Jack
Output Rear Panel Minimum Load Impedance Maximum Output Level Connector Type	Balanced: 22 Ω , XL / Unbalanced: 44 Ω Greater than or equal to 600 Ω Balanced and Unbalanced, +24dBu (12.3Vrms) into 600 Ω 1/4" TRS Phone Jack and XLR-type Connector
Distortion THD IMD	<0.2%, Any amount of compression @ 1kHz <0.2% SMPTE
Equivalent Input Noise	-89dBu
Dynamic Range	113dB
Gain Adjustment (Level Matching)	Variable from -20dB to +20dB
Threshold Threshold Characteristics	Compressor -40dBu to +20dBu Selectable OverEasy [®] or Hard Knee
Compression Ratio	Variable 1:1 - ∞ :1 thru to -1:1; >60dB Maximum Compression
Attack Time	Program-Dependent; 15ms for 10dB, 5ms for 20dB, 3ms for 30dB
Release Time	Program-Dependent; 8ms for 1dB, 80ms for 10dB, 400ms for 50dB; 125dB/sec Rate
Stereo Coupling	True power summing; 1/4" TRS Phone Jack
Operating Voltage	DO: 90 - 130VAC, 50/60Hz EU: 220 - 240VAC
Operating Temperature	0°C to 45°C (32°F to 113°F)
Dimensions (H x W x D)	1.75" x 19" x 9.25" (4.45cm x 48.2cm x 23.4cm)
Rack Space	1 Rack Unit (1U High)
Weight	Net Weight: 6.5 lbs (3kg) Shipping Weight: 9 lbs (4kg)
Warranty	dbx standard two-year warranty

1.0 INTRODUCTION

1.1 PRODUCT DESCRIPTION

The dbx Model 160X is a single channel compressor/limiter that features an exclusive *combination of the dbx Over Easy and "hard knee"* compression characteristics. dbx Over Easy compression permits extremely smooth, almost inaudible transitions into compression due to the gradual change of compression ratio around the threshold. The 160X offers the user the choice of using the Over Easy curve or a mathematically precise "hard" threshold—at any compression ratio selected. The Over Easy curve, coupled with dbx's true-RMS level detector, wide-range Blackmer voltage-controlled amplifier (VCA) and feed-forward circuitry, makes it *possible to achieve large amounts of compression without adverse audible side effects*. These features also allow the 160X to actually be set for *INFINITY+™* compression. This is a special negative compression effect whereby the program dynamics are inverted above the set threshold (i.e., the higher the input level, the lower the output level).

The detectors of two Model 160X's can be coupled so that stereo programs are compressed with stable imaging, by means of a simple patch cable between the two units. *The stereo coupling can be disengaged instantly by a front panel pushbutton.*

Program-dependent attack and release times assure natural sound without the need for continuous manual adjustments. *Threshold and compression ratios are adjustable over a wide range*, so virtually any line level signal can be processed effectively. *Output gain is also adjustable over a very wide range (± 20 dB)*. These features make the Model 160X compatible with the operating levels of virtually all professional sound and creative audio equipment.

For metering, the 160X provides a true RMS dual wide-range LED array which simultaneously shows *the amount of gain reduction up to 40 dB* and the input or output level from -40 dB to +20 dB*, depending on the setting of a front panel switch.

The 160X also features a true "hard-wired bypass" switch, separate detector inputs, Tip/Ring/Sleeve phone jacks as well as barrier strip connectors, balanced active inputs and +24 dBm single-ended output drive capability which can be field-modified to provide transformer or active balanced operation.

The dbx Model 160X is well suited to a broad range of applications including tape recording, disc mastering, radio and TV production and broadcast, live concert sound reinforcement, mobile and theatrical production.

IMPORTANT FOR UK USERS

The wires in this mains lead are colored in accordance with the following code:

Blue: Neutral
Brown: Live

As the colors of the wires in the mains lead of this apparatus may not correspond with the colored markings identifying the terminals in your plug, proceed as follows:

The wire that is colored blue must be connected to the terminal that is marked with the letter N or colored black;

The wire that is colored brown must be connected to the terminal that is marked with the letter L or colored red.

Ensure that all terminals are securely tightened and that there are no loose strands of wire.

WARNING

This unit must be protected by a 3-amp fuse, preferably using a fused plug. Also, do not remove the cover without first disconnecting the unit from the mains supply.

*The 160X is capable of greater than 60 dB of compression.

1.2 160X FRONT PANEL

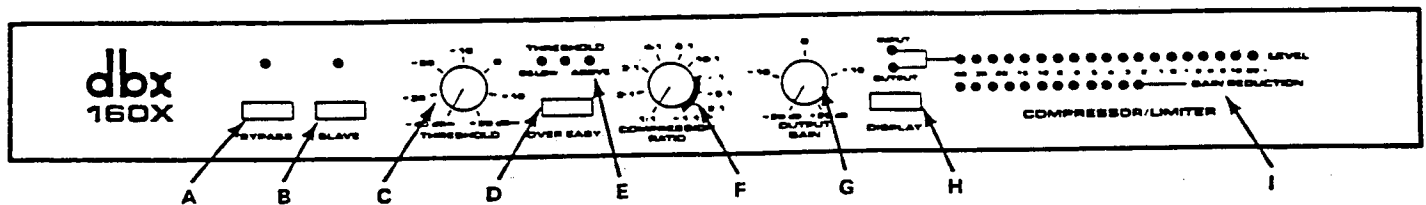

Fig. 1-1 — Model 160X Front Panel

A. BYPASS SWITCH AND INDICATOR

Depressing the BYPASS button creates a "hard-wire bypass" of the 160X's circuitry by connecting the input directly to the output; the LED above the switch turns ON in Bypass mode.

B. SLAVE SWITCH AND INDICATOR

Depressing the SLAVE button on one 160X of a stereo pair determines that the *other* 160X will be the Master (the controlling unit). The LED above the SLAVE button turns ON when the 160X is in SLAVE mode, indicating that the front panel functions (with the exception of BYPASS and DISPLAY select switches) are deactivated and under control of the Master 160X. When neither 160X is in SLAVE mode, each will operate normally as a mono compressor/limiter.

C. THRESHOLD CONTROL

Adjusting this knob sets the threshold of compression from -40 dBm (7.8 mV) to 20 dBm (7.8 V). In hard-knee compression mode, the threshold is defined as that point above which the output level no longer changes on a 1:1 basis with changes in the input level. In Over Easy mode, the threshold of compression is defined as the approximate middle of the Over Easy threshold region, as shown in Figure 3-1.

D. OVER EASY SWITCH

Depressing this button changes the threshold mode to dbx's Over Easy characteristic, and allows the middle (amber) THRESHOLD LED to turn ON when the signal is in the Over Easy region. When this button is out, the 160X operates as a hard-knee compressor/limiter.

E. THRESHOLD INDICATORS

These three LEDs indicate the relationship of the input signal level to the threshold of compression. The green "BELOW" LED is ON when the signal is below threshold and the red "ABOVE" LED is ON when the signal is above threshold. When the 160X is switched to Over Easy mode, the amber LED is ON when the signal is in the Over Easy region (Refer to Figure 3-1).

F. COMPRESSION RATIO CONTROL

Rotating this control in a clockwise direction increases the maximum amount of compression from 1:1 (no compression) up to infinity:1 (no increase in RMS output regardless of input level increases above threshold); further clockwise rotation increases compression into the INFINITY+ region, up to a maximum of -1:1 (i.e., a 1 dB decrease in input level causes a 1 dB increase in output level). In the INFINITY+ region, the 160X inverts the program dynamics for special effects.

G. OUTPUT GAIN CONTROL

Adjusting this control varies the amount of fixed gain (up to ± 20 dB) in the 160X's output amplifier stage. The OUTPUT GAIN control *does not* interact with the threshold of compression.

H. DISPLAY FUNCTION SWITCH AND INDICATORS

Depressing this button causes the upper LED array to display the INPUT level to the 160X. With the button out, the OUTPUT signal level is displayed. A pair of LEDs immediately above the DISPLAY switch indicates the selected display status.

I. LEVEL AND GAIN REDUCTION DISPLAYS

The upper row of 19 LEDs displays either the INPUT or OUTPUT level, as selected with the DISPLAY switch. This display is factory set so that 0 dB is equivalent to +4 dBm input or output level (1.23 V rms), but may be reset with the rear panel METER CALIBRATION trimmer. (See Section 3.5 for recalibration instructions.)

The lower row of 12 LEDs displays up to 40 dB of GAIN REDUCTION being caused by the 160X. (Fixed gain changes commanded by the OUTPUT GAIN control are not displayed by the gain change LEDs but are reflected in the output level display.)

1.3 160X REAR PANEL

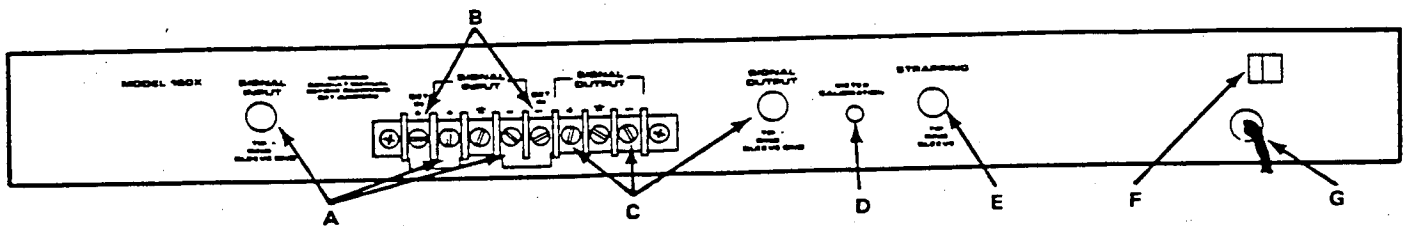

Fig. 1-2 — Model 160X Rear Panel

A. SIGNAL INPUT JACK AND TERMINALS

The Tip/Ring/Sleeve phone jack and barrier strip are wired in parallel; either SIGNAL INPUT accepts the incoming audio signal for processing by the 160X. The phone jack accepts a standard 3-circuit 1/4-inch (6.3 mm) phone plug for a balanced input source, or a 2-circuit (Tip/Sleeve) phone plug for an unbalanced source.

B. DETECTOR INPUT (DET IN) TERMINALS

The 160X comes from the factory with these terminals connected to the adjacent SIGNAL INPUT (+) and (-) terminals by metal straps. By removing the strapping, the detector input can be separated from the signal input for special processing applications.

C. SIGNAL OUTPUT JACK AND TERMINALS

The Tip/Ring/Sleeve phone jack and barrier strip are wired in parallel; either SIGNAL OUTPUT feeds the program from the 160X to the next device in the audio path. As supplied from the factory, the output (-) is internally connected to the output (+) whenever the 160X is *not* in bypass mode (see Section 2.4 for optional output configurations).

D. METER CALIBRATION CONTROL

This screw-driver-adjustable trimmer may be used to precisely calibrate the front panel's upper LED display so a 0 dB INPUT or OUTPUT level is equivalent to any signal level from -15 dBm (138 mV) to +10 dBm (2.45 V).

E. STRAPPING JACK

When a suitable patch cord (Tip/Ring/Sleeve phone plugs on a 2-conductor, shielded cable) joins this connector to the STRAPPING jack on another Model 160X, and when one of the units is switched to SLAVE mode, the two units may then be utilized for processing a stereo program.

F. AC LINE VOLTAGE REQUIREMENT INDICATOR

This recessed indicator displays the nominal AC line voltage for which the 160X has been set at the factory.

G. AC POWER CABLE

Connect this cable to any 50 or 60 Hz AC power source of the correct line voltage, as shown by the AC LINE VOLTAGE Requirement Indicator above. The Model 160X requires a maximum of 12 watts AC power.

WARNING:

Be sure to verify both the actual line voltage and the voltage for which your Model 160X was wired, as indicated on the rear panel of your unit. Connection to an inappropriate power source may result in extensive damage which is not covered by the warranty.